



Larynx & Tonsils (Tonsil Knife, Dissectors & Gauze Packers)

serrated



FISHER
220.22
22.5 cm/9"



BRUENINGS
228.23
23 cm/9"

Tonsil knife

4.5 mm



9 mm

CARPENTER
269.25
25 cm/10"

Tonsil Dissector

11 mm



14 mm

HURD
281.22
22.5 cm/9"



HENKE
24.5 cm/9¾"

serrated

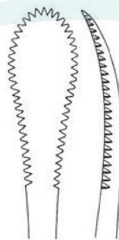

11.5 mm

289.23

5 mm

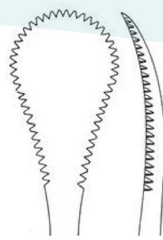

16.5 mm

291.23

5 mm



Gauze Packers



3 mm

311.19

3 mm

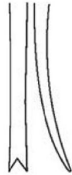

LUNIATSCHEK
17.5 cm/7"



2 mm

311.20

2 mm



Gauze Packers



2 mm

313.17

2 mm



LUNIATSCHEK
17.5 cm/7"



Larynx & Tonsils (Tonsil Forceps & Tonsil Snares)

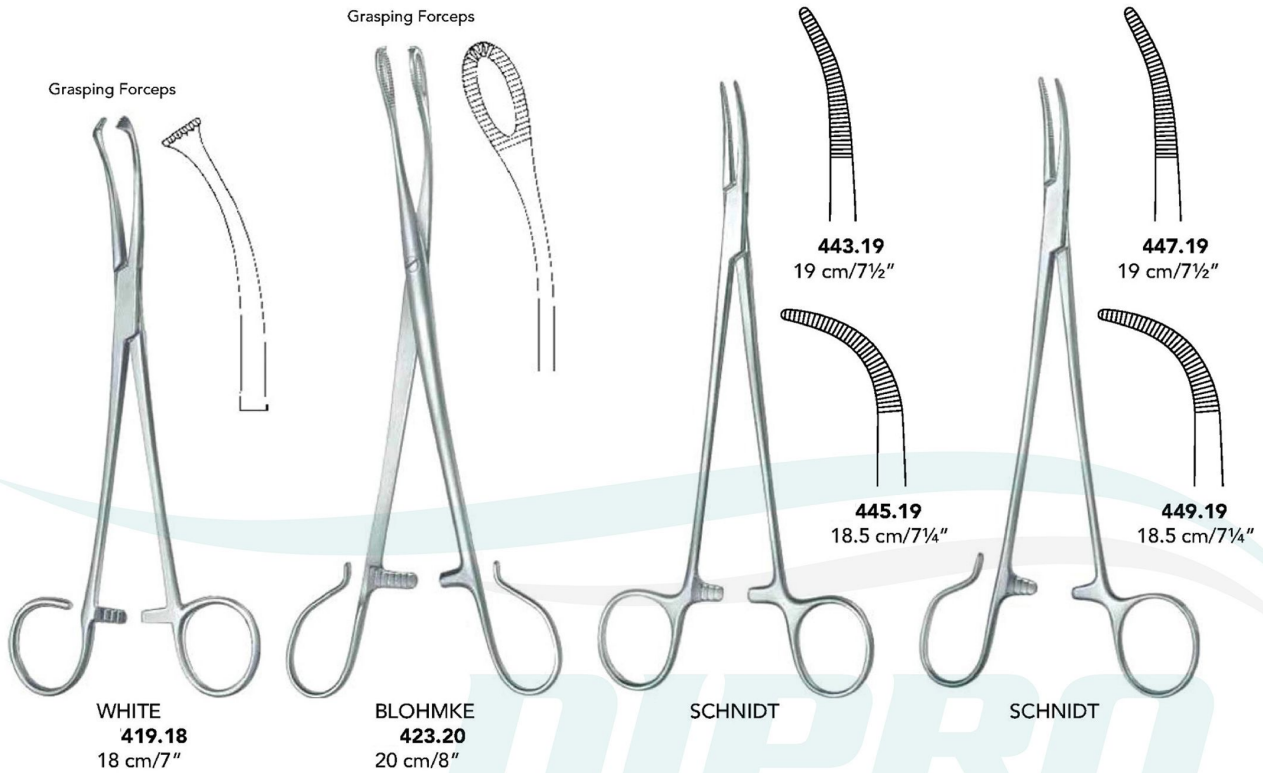

Ø 6 mm

Ø 6 mm

Ø 6 mm



EVES
500.28
28.5 cm/11¼"



EVES
502.28
28.5 cm/11¼"



BRUENINGS
506.28
29 cm/11½"

Wire Loop, package of 100 pieces

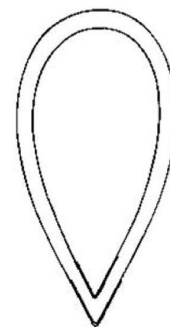

Ø 40 x 0.3 mm 511.40
Ø 50 x 0.3 mm 511.50



Larynx & Tonsils (Broncho-Esophagoscopy Forceps)

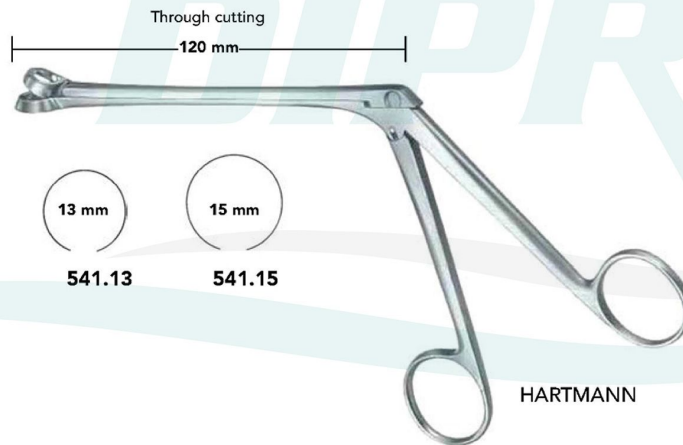
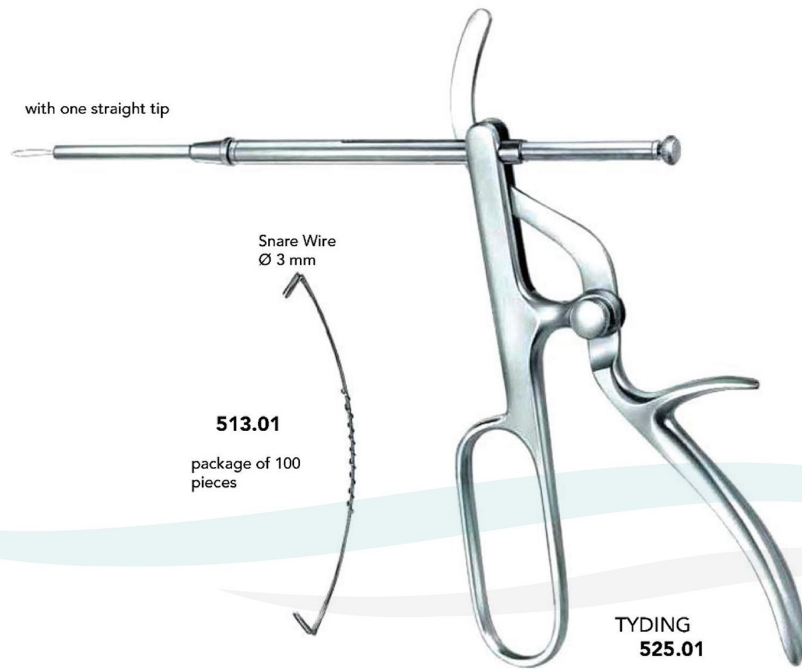

BRÜNINGS

22 cm/8¾"	584.20
32 cm/12¾"	584.30
41 cm/16¼"	584.40



BRÜNINGS
587.20
18 cm/7"



HUBER
581.01



Larynx & Tonsils (Exchangeable Tips)



FRAENKEL
600.01



SEIFFERT
604.01



FRAENKEL
608.01



SCHEINMANN
611.01



SCHEINMANN
613.01



BRUENINGS
Fig. 2 **616.02**
Fig. 3 **616.03**



BRUENINGS
Fig. 2 **618.02**
Fig. 3 **618.03**



LANGE
624.01



KRAUSE
Fig. 1 **628.01**
Fig. 2 **628.02**



KRAUSE
632.01



CORDES
Fig. 1 **637.01**
Fig. 2 **637.02**
Fig. 3 **637.03**
Fig. 4 **637.04**



SCHUMACHER
639.01



CORDES
Fig. 1 **643.01**
Fig. 2 **643.02**



CORDES
647.01



ROSENBERG
657.01

25 cm



1100.01 Ø 2 mm
Düz/Straight



1000.26
Düz/Straight $\frac{1}{16}$



1100.02 Ø 2 mm
Sola eğri
Curved to left



1000.27
Sola eğri
Curved to left



1100.03 Ø 2 mm
Yukarı doğru açılı
Upwards angled



1000.28
Sağa eğri
Curved to right



1100.04 Ø 2 mm
Sağa eğri
Curved to right



1000.29
Yukarı doğru açılı
Upwards angled



1100.05
Düz/Straight



1100.06
Sola eğri
Curved to left



1100.07
Sağa eğri
Curved to right



Larynx & Tonsils (Laryngeal Mirrors)



MICHEL
27 cm/7½"

Fig.	Ø	Price
1	12 mm	789.12
2	14 mm	789.14
3	16 mm	789.16
4	18 mm	789.18

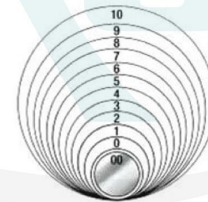
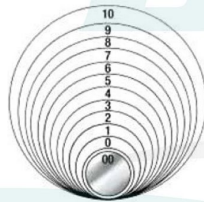

plane, with fixed handle



18.5 cm/7¼"

Fig. 00	Ø 8 mm	781.08
Fig. 0	Ø 10 mm	781.10
Fig. 1	Ø 12 mm	781.12
Fig. 2	Ø 14 mm	781.14
Fig. 3	Ø 16 mm	781.16
Fig. 4	Ø 18 mm	781.18
Fig. 5	Ø 20 mm	781.20
Fig. 6	Ø 22 mm	781.22
Fig. 7	Ø 24 mm	781.24
Fig. 8	Ø 26 mm	781.26
Fig. 9	Ø 28 mm	781.28
Fig. 10	Ø 30 mm	781.30

RHODIUM

Fig. 00	Ø 8 mm	782.08
Fig. 0	Ø 10 mm	782.10
Fig. 1	Ø 12 mm	782.12
Fig. 2	Ø 14 mm	782.14
Fig. 3	Ø 16 mm	782.16
Fig. 4	Ø 18 mm	782.18
Fig. 5	Ø 20 mm	782.20
Fig. 6	Ø 22 mm	782.22
Fig. 7	Ø 24 mm	782.24
Fig. 8	Ø 26 mm	782.26
Fig. 9	Ø 28 mm	782.28
Fig. 10	Ø 30 mm	782.30

plane, without handle



13.5 cm/5¼"

Fig. 00	Ø 8 mm	785.08
Fig. 0	Ø 10 mm	785.10
Fig. 1	Ø 12 mm	785.12
Fig. 2	Ø 14 mm	785.14
Fig. 3	Ø 16 mm	785.16
Fig. 4	Ø 18 mm	785.18
Fig. 5	Ø 20 mm	785.20
Fig. 6	Ø 22 mm	785.22
Fig. 7	Ø 24 mm	785.24
Fig. 8	Ø 26 mm	785.26
Fig. 9	Ø 28 mm	785.28
Fig. 10	Ø 30 mm	785.30

RHODIUM

Fig. 00	Ø 8 mm	786.08
Fig. 0	Ø 10 mm	786.10
Fig. 1	Ø 12 mm	786.12
Fig. 2	Ø 14 mm	786.14
Fig. 3	Ø 16 mm	786.16
Fig. 4	Ø 18 mm	786.18
Fig. 5	Ø 20 mm	786.20
Fig. 6	Ø 22 mm	786.22
Fig. 7	Ø 24 mm	786.24
Fig. 8	Ø 26 mm	786.26
Fig. 9	Ø 28 mm	786.28
Fig. 10	Ø 30 mm	786.30



Larynx & Tonsils (Laryngeal Polypus Forceps)

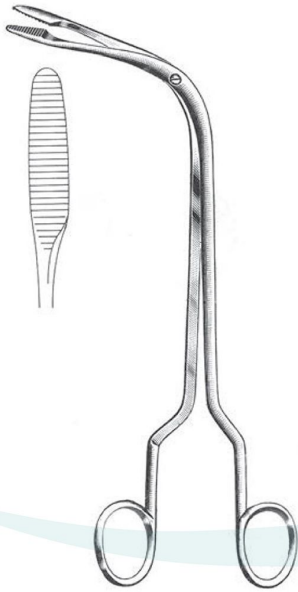

FRAENKEL
805.19
18 cm/7"

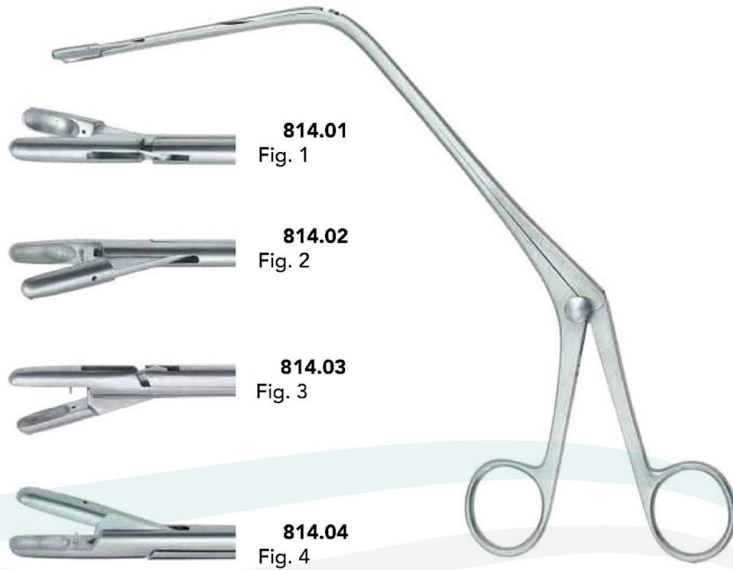

814.01
Fig. 1

814.02
Fig. 2

814.03
Fig. 3

814.04
Fig. 4

JURASZ
23 cm/9"

Tampon forceps

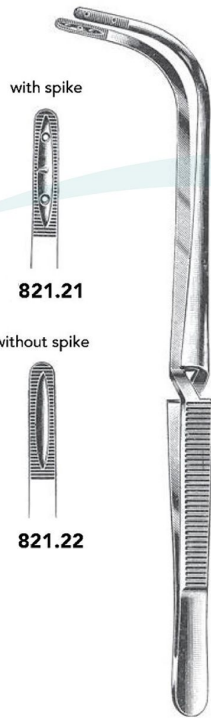

with spike

821.21

without spike

821.22

JACKSON
22 cm/8¾"

Epiglottis Retractor

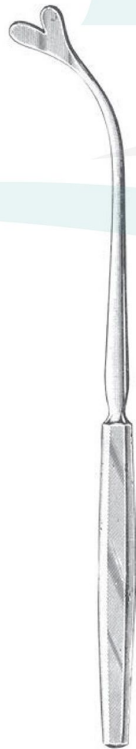

REICHERT
831.24
24 cm/9½"

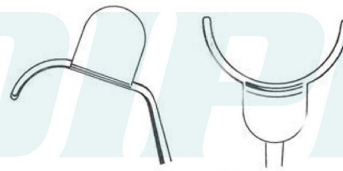

Tonsillectomy
Retractor

HOFER
329.24
24 cm/9½"



Soft Plate
Retractor

NAGER
331.23
24 cm/9"



Larynx & Tonsils (Mouthgags & Tongue Depressors)

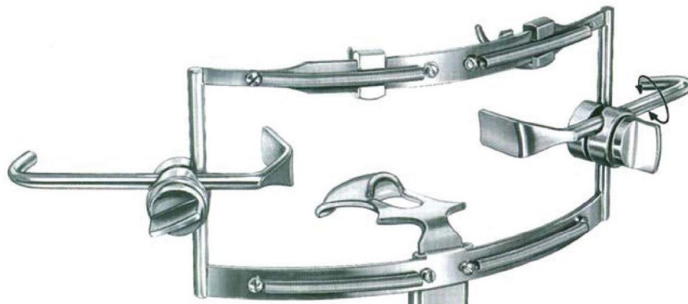

224.00
Complete set

1000.06
Mouth gag only



McIVOR
222.00
Complete set



Fig. 3

Fig. 1

Fig. 2

Fig. 3

DINGMANN

222.01

222.02

222.03

224.01

224.02

224.03

Tongue depressors



36 mm



297.38
14.5 cm/5½"

43 mm



297.45
15 cm/6"

WIEDER

JENNINGS

9.0 cm/3½"	237.09
11 cm/4½"	237.11
13.0 cm/5"	237.13
15.0 cm/6"	237.15

WHITEHEAD

9.0 cm/3½"	1000.36
11 cm/4½"	1000.37
13.0 cm/5"	1000.38
15.0 cm/6"	1000.39





Larynx & Tonsils (Mouthgags & Tongue Spatulas)



$\frac{1}{2}$
KILNER-DOUGHTY
1000.05



1
DAVIS-BOYLE
1000.09 Çocuklar için/For children
1000.10 Gençler için/For adolescents



$\frac{1}{2}$
DAVIS-BOYLE
1000.35
Büyükler için/For adults



$\frac{1}{2}$
DOYEN-COLLIN
1000.01
12 cm



$\frac{1}{2}$
DOYEN-JANSEN
1000.02
14 cm



1000.43
62 X 25 mm

1000.44
75 X 25 mm

1000.45
92 X 25 mm

1000.46
108 X 25 mm

1000.42
25 X 19 mm
DAVIS-BOYLE

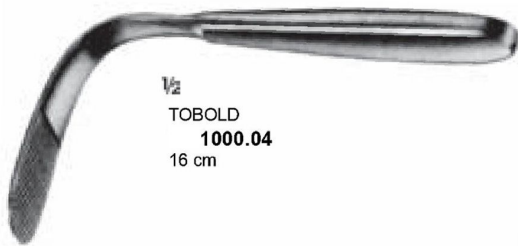

$\frac{1}{2}$
TOBOLD
1000.04
16 cm



$\frac{1}{2}$
HARTMANN
1000.07
15 cm



Larynx & Tonsils (Mouthgags & Tongue Depressors)



$\frac{1}{2}$
DENHARDT
1000.48
Değiştirilebilir silikon parçalı
Silicon inserts interchangeable
12.5 cm



$\frac{1}{2}$
FERGUSSON-ACKLAND
1000.49
14.5 cm



$\frac{1}{2}$
ROSER-KÖNIG
1000.50
16 cm



$\frac{1}{2}$
ROSER-KÖNIG
1000.51
18.5 cm

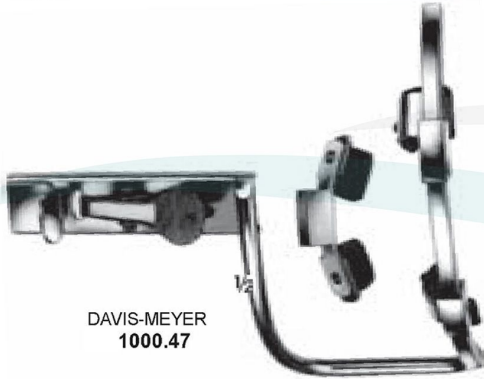

$\frac{1}{2}$
DAVIS-MEYER
1000.47



1000.30
67 X 29 mm

1000.31
75 X 33 mm

1000.32
85 X 38 mm

1000.33
92 X 40 mm

$\frac{1}{2}$
1000.34
100 X 46 mm

$\frac{1}{2}$
RUSSEL-DAVIS
1000.30 - 1000.31



Larynx & Tonsils (Mouthgags & Tongue Depressors)

Tongue spatulas



MOLT
161.11
11 cm/5½"



MOLT
161.14
14 cm/5½"



SCHMID
1000.40



HEISTER
1000.41
13 cm



DOYEN
375.13A 23 x 30 mm
13.5 cm/5¼"
375.13 30 x 33 mm
16 cm/6¼"

Cheek retractor

Swivel

35 mm

19 x 15 mm



BRUENINGS
385.19
19 cm/7½"



350.16
16 cm/6¼"



384.19
19 cm/7½"

24 x 27 mm

Tongue holding forceps



COLLIN
452.17
17 cm/6¾"



YOUNG
467.17
15 cm/6"

Pair Rubber Inserts

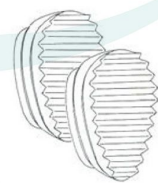

EM468.02



Larynx & Tonsils (Tracheal Dilators & Tracheal Hooks)



LABORDE
EY113.14
14 cm/5½"



TROUSSEAU
EY115.14
14.5 cm/5¾"



ITERSON
Sharp Blunt
EY125.16 **EY127.16**
17 cm/6¾"



ROSE
EY143.13
15.5 cm/6¼"



LUER
EY145.11
11 cm/4½"



LAHEY
15.5 cm/6¼" **EY449.15**
20.0 cm/8" **EY449.20**



LUKENS
EY151.17
11 cm/4¼"



JACKSON
EY155.17
18 cm/7¼"



KOCHER
EY411.15
15.5 cm/6¼"



with eye
KOCHER
EY413.15
15.5 cm/6¼"